



HEIDENHAIN



**Functional
Safety**

Product Information

EIB 3392 S

Signal Converter
in Cable Design

EIB 3392 S

Signal converter in cable design with firmware version 15

- **Input:** HEIDENHAIN encoders with EnDat22 interface
- **Output:** DRIVE-CLiQ interface

Encoder requirements

The EIB 3392 S makes it possible to connect encoders with the ordering designation EnDat22 to the DRIVE-CLiQ interface.

Depending on the firmware version of the EIB and the subsequent electronics, it might be possible to also attach other encoders with an EnDat22 interface. Please contact HEIDENHAIN or the manufacturer of the subsequent electronics for further information.

After switch-on, the EIB tests various characteristics of the connected encoder and automatically adapts itself to it. If the encoder does not meet the necessary requirements, an error message is issued via the DRIVE-CLiQ interface.

TIME_MAX_ACTVAL

The calculation time TIME_MAX_ACTVAL specifies the earliest time (relative to the request time) after which the transfer of data from the encoder to the control can begin.

The value depends on the parameters of the connected encoder (calculation time and resolution) and the cable length. Furthermore, there can be restrictions when setting the cycle times. For more information, please refer to the documentation for the DRIVE-CLiQ subsequent electronics.

Online diagnostics

With EnDat 2.2 encoders, valuation values can be read cyclically from the encoder to evaluate its functioning. The valuation numbers provide the current state of the encoder and ascertain the encoder's "function reserves." These function reserves are also transferred over the DRIVE-CLiQ interface and can be displayed in the higher-level control. Further information is available from HEIDENHAIN upon request.

Fastening

The EIB 3392 S must be fastened. This is possible, for example, with a 20 mm cable clamp (see also "Dimension drawing").

Power supply of encoder

The EIB 3392 S provides voltage of $U_P = 8.0 \text{ V}$ to the encoder. Please comply with the supply voltage range of the connected encoder. Due to their voltage range, certain encoders with the ordering designation EnDat22 cannot be connected, e.g. LC 1x3, LC 4x3, and ECN 225.

	Compatible with EIB 3392 S
Absolute sealed linear encoders LC 100, LC 400, LC 200	✓
Absolute exposed linear encoders LIC 4100, LIC 3100, LIC 2100	✓
Absolute angle encoders RCN 2001, RCN 5001, RCN 8001, RCN 6000 ROC 2000, ROC 7000 ECN 2000 ECA 4000 ECM 2400 MRP 2000, MRP 5000, MRP 8000 SRP 5000	✓ ✓ ✓ ✓ ✓ ✓ ✓
Absolute singleturn encoders , such as ECN 100 ECI 100, ECI 1100, ECI 1300	✓ ✓
Absolute multiturn encoders , such as EQI 1100, EQI 1300	✓
Length gauges AT 3000 AT 1200	✓ ✓
Incremental EnDat encoders , such as ERM 2400, LIP 200, EIB 100, EIB 300, EIB 1500	–
Encoders with battery-buffered revolution counter , such as EBI 100, EBI 1100, EBI 4000	–

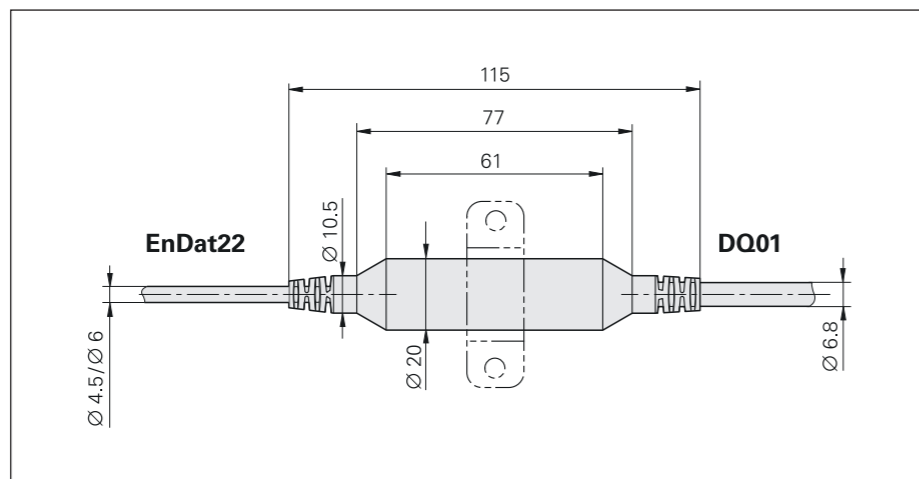

Firmware versions

The firmware version can be read out over the DRIVE-CLiQ parameter "Act_FW_Version" (index 0). The final two digits of the displayed value are decisive.

Specifications	EIB 3392 S
Functional safety	Depending on the connected encoder and subsequent electronics, suited for applications with up to <ul style="list-style-type: none"> • SIL 2 as per EN 61508 (further basis for testing: EN 61800-5-2) • Category 3 PL d as per EN ISO 13849-1:2016-06
PFH	$26 \cdot 10^{-9}$ (with respect to an operating elevation of $\leq 1000 \text{ m}$ above sea level)
Safe position	Determined by the connected encoder and the subsequent electronics (i.e. through the configuration); the EIB has no influence on the safe position
Input	
Interface	EnDat 2.2
Ordering designation	EnDat22 (note the <i>Encoder requirements</i>)
Electrical connection	Various connectors (see <i>Versions of the EIB 3392 S</i>)
Encoder supply voltage (U_{P2})	DC 8.0 V $\pm 0.4 \text{ V}$, max. 1800 mW
Cable length	$\leq 30 \text{ m}^1$
Output	
Interface	DRIVE-CLiQ
Firmware	01.32.27.15
SINAMICS, SIMOTION ²⁾	$\geq \text{V4.6HF3}$
SINUMERIK with safety ²⁾	$\geq \text{V4.7 SP1 HF1}$
SINUMERIK without safety ²⁾	$\geq \text{V4.5 SP2 HF4}$
Calculation time TIME_MAX_ACTVAL	Refer to <i>TIME_MAX_ACTVAL</i> on page 2
Ordering designation	DQ01
Electrical connection	Various connectors (see <i>Versions of the EIB 3392 S</i>)
Cable length	$\leq 30 \text{ m}^3$
Supply voltage (U_{P1})	DC 24 V (16.0 V to 28.8 V) (up to DC 36.0 V possible without impairing functional safety)
Power consumption	<i>Maximum</i> At 16.0 V: $\leq 3200 \text{ mW}$ At 28.8 V: $\leq 3300 \text{ mW}$ <i>Typical</i> At 24 V: $1000 \text{ mW} + 1.15 \times P_{Mtyp}$ (with P_{Mtyp} = typical power consumption of the encoder)
Elevation	$\leq 1000 \text{ m}$
Operating temperature	0 °C to 60 °C
Storage temperature	-30 °C to 70 °C
Vibration 55 Hz to 2000 Hz Shock 11 ms	100 m/s^2 (IEC 60068-2-6) 200 m/s^2 (IEC 60068-2-27)
Protection rating EN 60529	IP65 ⁴⁾
Mass	$\approx 0.2 \text{ kg}$ (with 1 m cable length on both sides)

¹⁾ With HEIDENHAIN cable. Comply with the supply voltage at the encoder

²⁾ Information from Siemens as per the document "Certified encoders with DRIVE-CLiQ Dependencies on SIMOTION / SINUMERIK and SINAMICS Hardware and Software versions" (version: 04/2019)

³⁾ Depending on the output cable; the plug connection to the EIB is to be considered a DRIVE-CLiQ coupling.

⁴⁾ Use the correct connector version

DRIVE-CLiQ is a registered trademark of SIEMENS AG.

Versions of the EIB 3392 S

Overview of connection options (the encoders are examples)

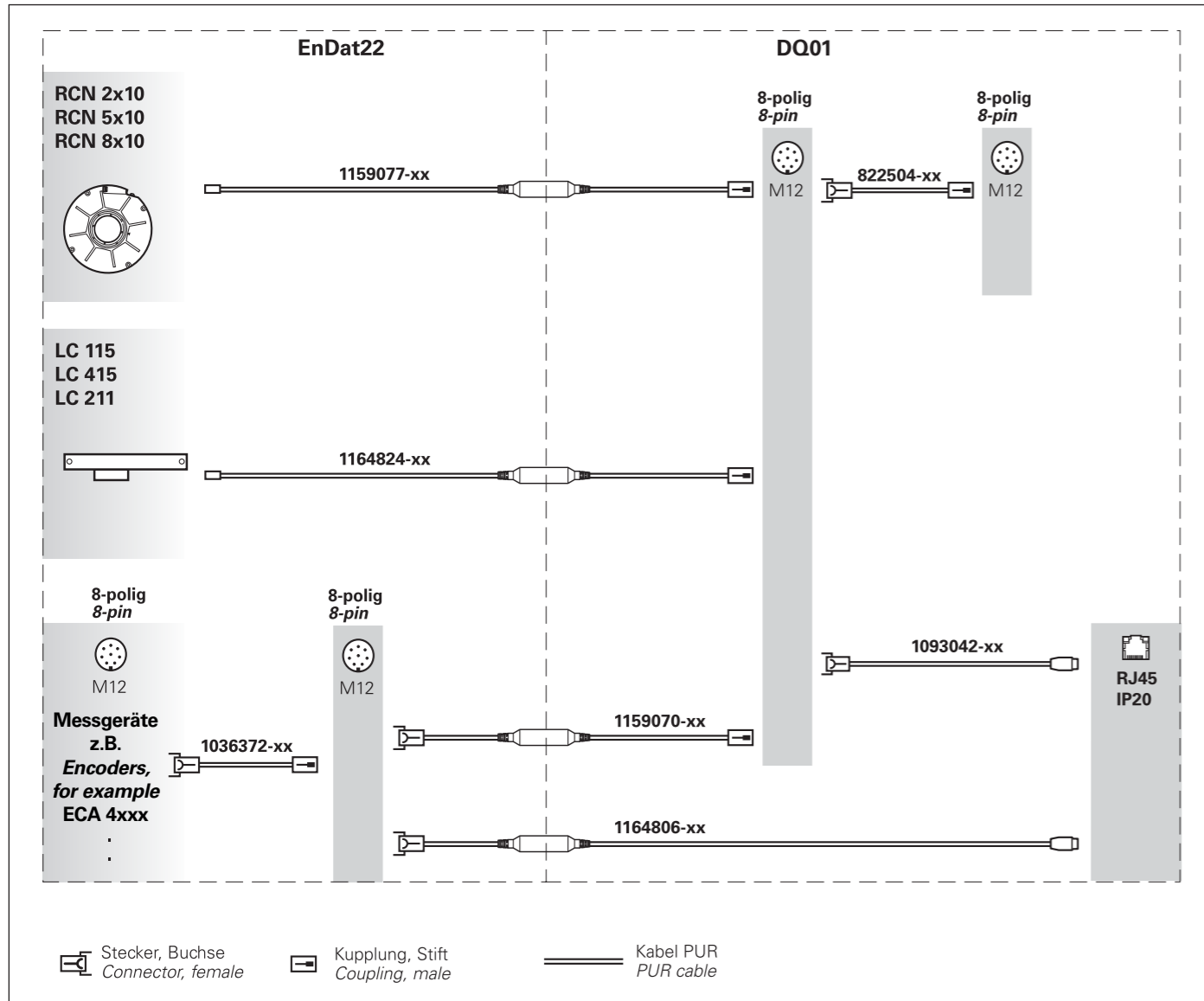

Overview of ID numbers for the EIB 3392 S

ID	Input			Output		
	Connecting elements	Cable Ø/A _P	Cable length	Connecting elements	Cable Ø/A _P	Cable length
1159077-11	12-pin ultra-lock connector (female)	4.5 mm/ 2 · 0.16 mm ²	2.5 m	8-pin M12 connector (male)	6.8 mm/ 1 · 0.24 mm ²	0.5 m
1164824-11	14-pin M12 connector (female)	4.5 mm/ 2 · 0.16 mm ²	2.5 m	8-pin M12 connector (male)	6.8 mm/ 1 · 0.24 mm ²	0.5 m
1159070-11	8-pin M12 connector (female)	6 mm/ 2 · 0.16 mm ²	1 m	8-pin M12 connector (male)	6.8 mm/ 1 · 0.24 mm ²	1 m
1164806-11	8-pin M12 connector (female)	6 mm/ 2 · 0.16 mm ²	0.5 m	6-pin RJ45 connector, IP20 (male)	6.8 mm/ 1 · 0.24 mm ²	2.5 m

A_P: Cross-section of wires for power supply voltage
Other versions are available upon request.

Temperature sensor information

The EIB 3392 S does not have a temperature sensor input, but it can evaluate the temperature sensor information from connected EnDat encoders and pass it through the DRIVE-CLiQ interface. Up to four types of temperature information can be transmitted. The EIB 3392 S supports transmission from:

- one internal temperature sensor (value is provided in the DRIVE-CLiQ parameter "Encoder Temperature")
- up to three external temperature sensors (values are provided in the DRIVE CLiQ parameter "Motor temperature 2-4"; the calculated highest value of the three sensors is output in the parameter "Motor temperature 1")

The EIB 3392 S can simultaneously process the information of one external and one internal temperature sensor. If more than one external temperature sensor is used, the value of the internal temperature sensor can no longer be provided.

The evaluation of the connected sensors can be set via the DRIVE-CLiQ interface, depending on the settings of the EnDat encoder. This allows temperature sensors of types KTY 84-130, PT 1000, and PTC to be evaluated. For more information, please contact HEIDENHAIN.

Designation of the connecting cables

The connection cables for input and output have differing colors.

The interfaces and their ordering designations "EnDat22" and "DQ01" are printed on the ID label. Arrows indicate the proper connection.

You can find further information on the availability and mapping of the temperature sensor information in the documentation of the connected EnDat encoder.

Functional safety

In principle, the EIB can be used in safety-related applications only if functional safety is supported by the connected encoder. The characteristics with regard to functional safety are substantially determined by the connected encoder and the subsequent electronics (if required, contact the manufacturer; the EIB basically conveys the characteristics of the encoder).

The **safe position** is also substantially determined by the connected encoder and the subsequent electronics. The EIB itself does not influence the safe position. The "safe position" and "safety-related measuring step (SM)" of the connected EnDat encoder are required to calculate the safe position. Please contact the manufacturer of the subsequent electronics for further information.

The **PFH value** of the total system (EIB 3392 S + encoder) is the sum of the PFH values of the EIB 3392 S and the connected encoder. For information on the encoder, please refer to its documentation (Product Information document, brochure, and mounting instructions).

The EIB 3392 S is designed for a **service life** of 20 years (in accordance with ISO 13849).

Please contact the manufacturer of the subsequent electronics for more information on the application of the EIB and encoder in safety-related applications.

Restrictions

With linear encoders featuring measuring lengths greater than 50 m, there may under certain circumstances be limitations in the output of the commutation angle via the DRIVE-CLiQ interface. Please contact HEIDENHAIN in such cases. HEIDENHAIN recommends setting the datum shift in the subsequent electronics. If the datum shift is used in the EnDat area, it must be less than 3 m, and no position values less than zero may result.



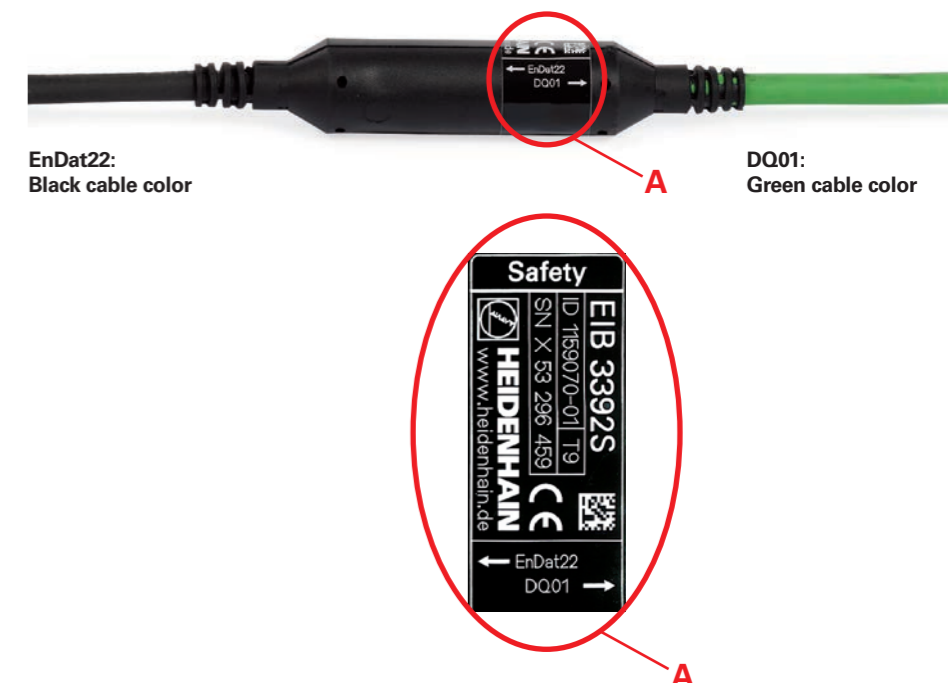

NOTE:

The software of the DRIVE-CLiQ subsequent electronics must be designed for operation of the EIB 3392 S in safety-related applications. For more information on availability, please refer to the manufacturer.





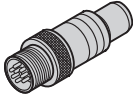

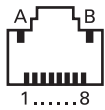

Interfaces

Pin layout of the EIB input

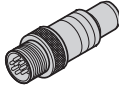
Mating connector 8-pin M12 coupling   								
	Power supply				Serial data transmission			
	8	2	5	1	3	4	7	6
EnDat	U _{P2}	Sensor U _{P2}	0V	Sensor 0V	DATA	DATA	CLOCK	CLOCK

Siemens pin layout

RJ45 connector  			8-pin M12 coupling   			
	Power supply		Serial data transfer			
	A	B	3	6	1	2
	1	5	7	6	3	4
	U _P	0V	TXP	TXN	RXP	RXN

Cable shield connected to housing; **U_P** = Power supply voltage

HEIDENHAIN

DR. JOHANNES HEIDENHAIN GmbH

Dr.-Johannes-Heidenhain-Straße 5

83301 Traunreut, Germany

☎ +49 8669 31-0

☎ +49 8669 32-5061

E-mail: info@heidenhain.de

www.heidenhain.de

This Product Information document supersedes all previous editions, which thereby become invalid. The basis for ordering from HEIDENHAIN is always the Product Information document edition valid when the order is placed.



Further information:

To ensure proper and intended use, comply with the specifications in the following documents:

- Brochure: *Interfaces of HEIDENHAIN Encoders* 1078628-xx
- Brochure: *Cables and Connectors* 1206103-xx
- Brochure, Product Information, and Mounting Instructions of the connected encoder
- Mounting Instructions: *EIB 3392 S* 1177939-xx